

HI-POWER EASY PULLER



PRE SELF-CENTERING



Hydraulic Pullers

HI-POWER PRE 2/3-arm Pullers, Self-centering



HI-POWER PRE 5000

HI-POWER, Safe and user-friendly dismantling of bearings, couplings, rings etc.

Separate 2-stage HI-POWER hand pump available

- Self-centering, easy to convert 2- or 3-arm puller.
- The arms slide inwards or outwards simultaneously.

Safe

- Arms can never deflect.

Economical

- 2- or 3-arm all in one puller.
- 2/3 jaws combination puller cross head with manganous-phosphate plated for rust proof and durability

Strong

- Heat treated & chrome plated hydraulic cylinder rod.
- The greater the pulling force.
- PRE-5000 also available with mobile crane.

Advantages of centering pullers :

- Heat treated forged alloy steel cross bolts & jaws with manganous-phosphate plated for rust proof & long life service.
- Prevent damage to shaft and workpiece being pulled.
- work efficient and save time.

4,8,12,20,30 and 50 ton capacity

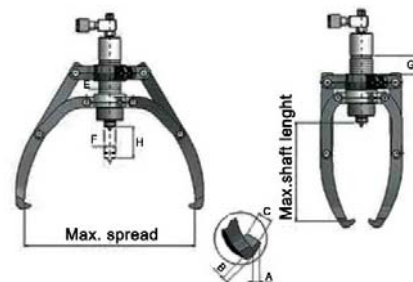
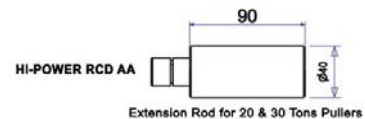
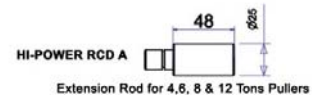

HI-POWER PRE hydraulic self-centering pullers.

Model No.	Cap. ton	Max. Shaft length (mm)	Reach		Spread		Stroke H mm	Pump tip mm			Jaw tip mm			Weight (kg)
			Max. (mm)	Min. (mm)	Max. (mm)	Min. (mm)		E	F	G	A	B	C	
HI-POWER PRE 400	4 Ton	190	190	150	315	43	60	42	22	40	13	10	22	7.4
HI-POWER PRE 800	8 Ton	280	280	225	460	95	85	42	22	40	13	10	22	13.9
HI-POWER PRE 1200	12 Ton	300	300	240	515	100	85	50	25	70	13	13	27.5	16.4
HI-POWER PRE 2000	20 Ton	325	325	250	520	110	111	60	28	70	15	16.5	29	43.5
HI-POWER PRE 3000	30 Ton	415	415	330	620	120	111	80	40	62	20	27	33	56.5
HI-POWER PRE 5000	50 Ton	455	455	296	860	160	159	98	50	85	20	27	38	140.0

*HI-POWER HI-QUALITY PULLERS, ALL INCL, HI-POWER SAFETY NET (SAFETY BLANKET)

HI-POWER HI-QUALITY

Hydraulic Professional Tools

HI-POWER®

HI-POWER HYDRAULIC PULLERS

2/3 Pullers, W/ HI-POWER Hand Pump 700 Bar



PR-Series



Hi-POWER PR-3000 with HI-POWER Hyd. Hand pump Pro set.

HI-POWER PR Series, 4-30 tons.

HI-POWER, Safe and user-friendly dismantling of bearings, couplings, rings etc.

Separate HI-POWER HAND PUMP PRO SET available

- Spring loaded live centering nut easy job (removable).
- Each arms slide flexible, Easily release valve.

Safe

- Arms can never deflect.

Economical

- 2- or 3-arm all in one puller.
- 2/3 jaws combination puller cross head with manganous-phosphate plated for rust proof and durability

Strong

- Heat treated & chrome plated hydraulic cylinder rod.
- The greater the pulling force.

Advantages :

- Heat treated forged alloy steel cross bolts & jaws with manganous-phosphate plated for rust proof & long life service.
- Provent damage to shaft and workpiece being pulled.
- Work efficient and save time.

4,8,12,20, and 30 tons capacity

* HI-POWER Steel case dimension : 72 x 18 x 18 cm.

* HI-POWER HI-QUALITY PULLERSM ALL INCL, HI-POWER SAFETY BLANKET

* Suggested HI-POWER HYDRAULIC HAND PUMP PRO SET 700 BAR, Suit to 4-30 tons puller set

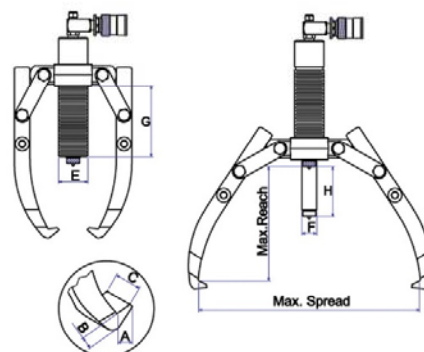
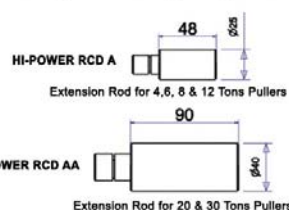

HI-POWER HYD. HAND PUMP PRO SET 700 Bar.



HI-POWER Puller

Model No.	Cap. ton	Max. Shaft length (mm)	Reach Max. (mm)	Spread Max. (mm)	Stroke H mm	Pump tip mm			Jaw tip mm			Weight (kg)
						E	F	G	A	B	C	
HI-POWER PR 400	4 Ton	185	185	255	60	42	22	84	11	6	22	8.0
HI-POWER PR 800	8 Ton	230	230	350	85	50	25	122	11	10	25	12.0
HI-POWER PR 1200	12 Ton	270	270	375	85	60	28	118	14	10	29.0	12.7
HI-POWER PR 2000	20 Ton	360	360	520	111	80	40	161	20	27	33	39.3
HI-POWER PR 3000	30 Ton	360	360	550	111	98	50	155	20	27	38	51.5

HI-POWER®

HI-POWER PULLER 2/3 JAWS PRO PLUS, PR SERIES SEPERATE HAND PUMP SET 700 BAR PULLER & UNIVERSAL BEARING ATTACHMENT SET PR SERIES



HI-POWER PRO PLUS SET including puller 2/3 jaws, HI-POWER Hand Pump Set jaw assembly, cross bearing,
HI-POWER HAND PUMP PRO SET

HI-POWER PULLER PRO PLUS SET

Model No.	Capacity	Reach	Reach	Strock	Pump Tip (mm)			Jaw Tip (mm)			Weight
	(ton)	(Max. mm) A	(Min. mm) B	(mm) H	C	D	E	A1	B1	C1	
PR420	4 Tons	211.5	131.5	60	42	22	80	11	6	22	4.5 / 8.5
PR820	8 Tons	243.5	121.5	85	50	25	122	11	10	25	6.5 / 12.6
PR1220	12 Tons	288	173	85	60	28	115	14	10	29	8.0 / 18.0

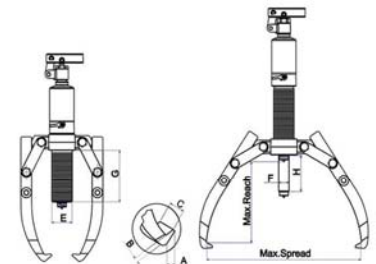

SRECFICATION HI-POWER Bearing attachment cross bearing set. (INCLUDING IN SET)

Model No.	Capacity	A (mm)	D (mm)	C (mm)	CC (mm)	Thread	Bearing Attachment	Weight (kgs)
	(ton)	Min-Max.	Min-Max.	Min-Max.	(inch)			
HI-POWER P412	4 tons	224	12-70	163	100-145	1/2"- 13UNC		6.5
HI-POWER P612	6 tons	255	28-150	260	115-220	5/8"- 11UNC	HYC9025	10.5
HI-POWER P812	8 tons	255	28-150	260	110-230	5/8"- 11UNC	HYC9025	11.5
HI-POWER P1212	12 tons	298	20-200	360	140-310	3/4"- 10UNC	HYC9035	20.0

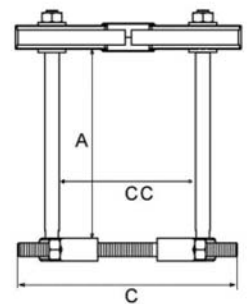

* Excluding the hydraulic pump body.

TECHNICAL DATA HI-POWER Bearing Attachments (INCLUDING IN SET)

Model No.	D	C	L	I	ØT	ØM	Weight
	Min-Max. (mm)						
HI-POWER HYC9005	5-60	17	120	92	3/8-24UNF	3/8-16UNC	0.7
HI-POWER HYC9010	15-60	20	135	130	1/2-20UNF	3/8-16UNC	1.5
HI-POWER HYC9015	12-70	27	165	156	5/8-18UNF	1/2-12UNC	2.6
HI-POWER HYC9025	28-150	33	275	207	3/4-16UNF	5/8-11UNC	5.0
HI-POWER HYC9035	20-200	38.5	350	240	1-14UN	3/4-10UNC	10.0
HI-POWER HYC9035A	20-200	38.5	350	240	1-14UN	1/14UN	11.0

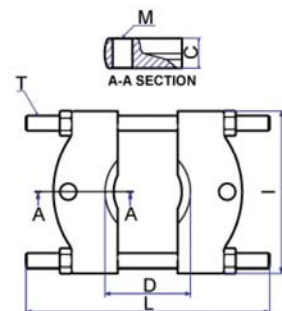

HI-POWER Tri Section Plate



Spreading - Rear Side



Spreading - Front Side



Swivel design creates wider spread.

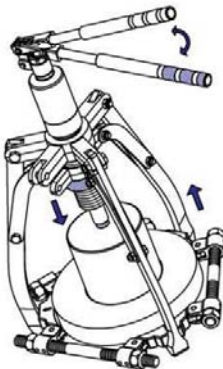

Easy Operating

USER-FRIENDLY & SAFE

- Unique & patented swivel design creates the max. spread.
- The tri-section construction provides the even force distribution, preventing bearing from locking and/or tilting on the shaft during dismantling.
- Suitable for combination usage with all three-armed hydraulic pullers.
- Available in a wide range, covering the most common shaft sizes.
- The firm grip behind inner and outer rings of bearing ensures the pulling force being transmitted through the moving parts and preventing the damaging of bearing.

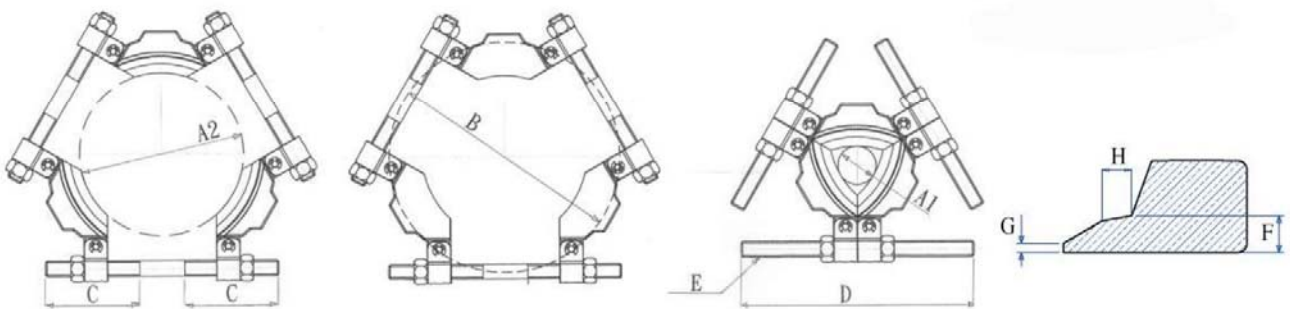

SPECIFICATIONS (mm)

Model No.	Available Shaft Dia.		Spread B (Max.)	C	D	E	F	G	H	Capacity (Ton)	Weight (kg)
	A1	A2									
T3-60	26	160	216	105	240	5/8"-11UNC	8	2	6.5	6	3.5
T3-210	50	210	280	117	285	7/8"-14UNF	10	2	9	8	5.5
T3-340	90	340	460	175	430	1 1/4"-12UNF	14	2	8	20	18
T3-495	140	495	660	235	610	1 3/4"-12UNF	20	2	12	30	45